

The K-Shaker Vibrating Roller discs clamp on to a standard 114 mm diameter return conveyor roller. The vibration caused by the discs can help to “knock-o ” carry back in a convenient location for cleaning up. The ideal installation is directly over a stockpile, bin or vibrating screen.

The discs are supplied with a separate clamp, or as a roller assembly. The vibrating roller will work in either direction, and is not affected by damaged belts with mechanical fasteners.

They are most effective at medium belt speeds and do not require any further attention after installation. The polyurethane discs are durable and their unique shape and hardness ensures continuous belt contact.

Key Benefits

- t & BTZ UP 'JU
- t \$PTU &'FDUJWF
- t .BJOUFOBODF 'SFF
- t 4VJUBCMF GPS BMM #FMU 8JEUIT

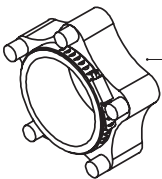
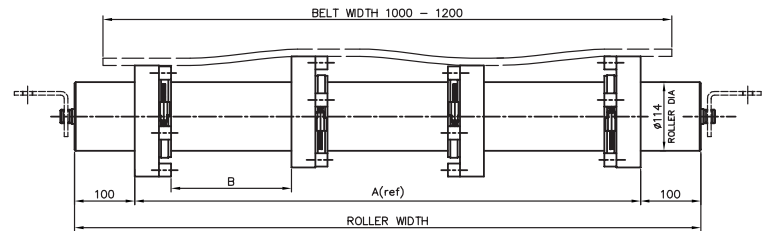
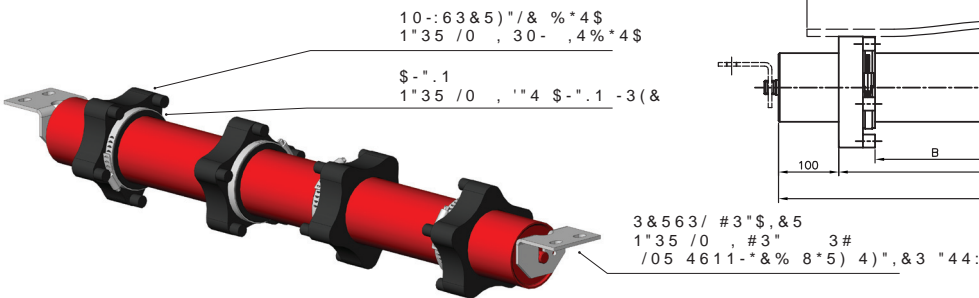
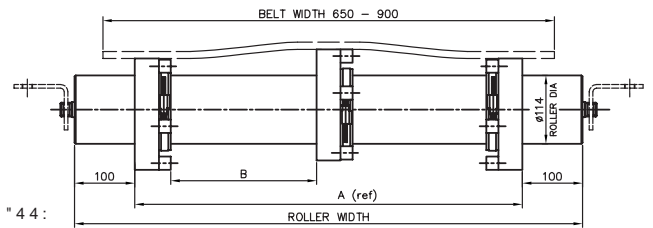
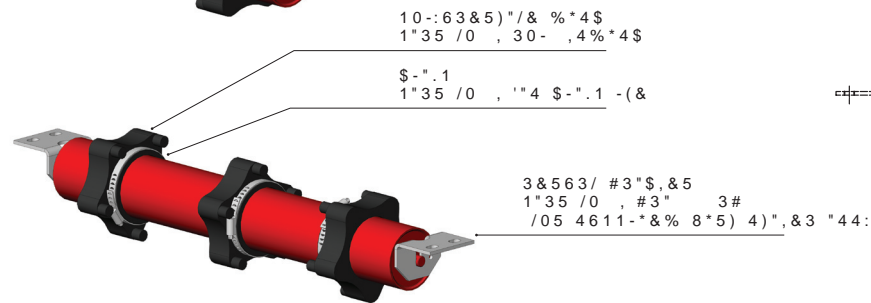
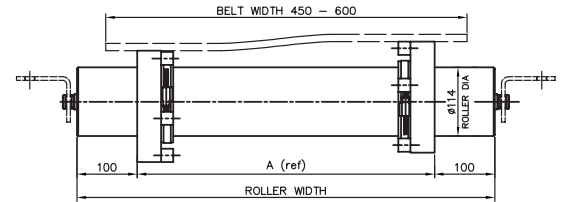
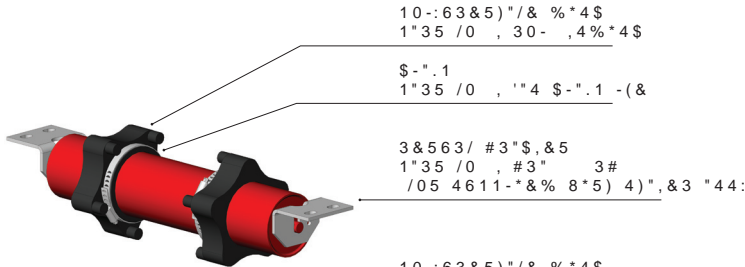

10-:63&5)"/& %*4\$ "44&.#-:
1"35 /0 , 30- ,4%*4\$ "44

1BSU /VNCFS	# FMU 8JEUI	Roller 8JEUI	% JTD	" SFG T /mm	# mm
, \$ - & , 433	"450	544	2	344	-
, \$ - & , 433	"500	594	2	394	-
, \$ - & , 433	"600	694	2	494	-
, \$ - & , 433	"650	744	3	544	182
, \$ - & , 433	"750	844	3	644	232
, \$ - & , 433	"900	994	3	794	307
, \$ - & , 433	1000	1094	4	894	218
, \$ - & , 433	1050	1144	4	944	235
, \$ - & , 433	1200	1294	4	1094	285